



## Hot Melt Technologies New Exchange Program (NXP)

### The Hot Melt Technologies Nxp™ Program Guarantees the Exchange Value of Your Equipment and Can Reduce Downtime

#### NXP Guarantees Value

The Hot Melt Technologies New Exchange Program (NXP) provides added value to your hot melt equipment investment by guaranteeing the value of your equipment and system components—no matter how old and worn out they get. NXP is available for:

- ▶ Tanks
- ▶ Pumps
- ▶ Hoses
- ▶ Handguns
- ▶ Automatic Guns
- ▶ Most Electronics

#### Protects Against Downtime

The Hot Melt Technologies Program can also help reduce downtime. For example, if your pump begins to show signs of wearing out (low flow), and you cannot afford to stop production for repairs, order a new NXP Pump. Keep your present pump in service until the new one arrives. Install it and send the old one back to us.

#### Benefits of the NXP Program

The NXP Program does not use reconditioned or rebuilt components and parts.

- ▶ With the NXP Program you are guaranteed all new components and parts.
- ▶ Each item is made and assembled to current HMT design specifications and factory quality standard.
- ▶ Each unit or component is covered by the full new product warranty.
- ▶ Immediate shipment is available on all stock items.
- ▶ HMT does not charge extra for same day shipment.
- ▶ You have up to 30 days to return the replaced item to us.
- ▶ The NXP Program applies regardless how old or worn out your component or unit is.

#### How the NXP Program Works

1. Call HMT's Customer Service or Technical Service and Support Department to determine the correct replacement component.
2. You will be quoted the discounted NXP Pricing, should it apply.
3. Place your order with Customer Service.
4. If directed to return the old item you will receive a tag with the NXP item with instructions.

Your participation in the Hot Melt Technologies NXP Program is that simple!





## New Exchange Program (Old for New)

### Available Component Exchange

#### Tank Modules

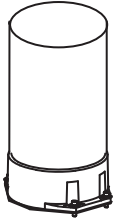

12-20 lb

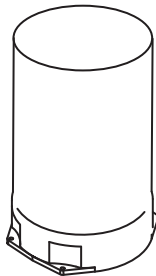

25-50 lb

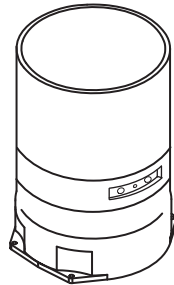

50 & 85 lb R.O.F.

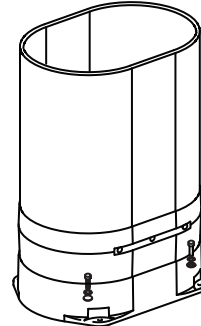

135-200 lb R.O.F.

#### Pump Assemblies, complete

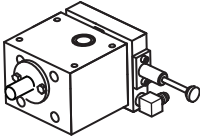

PA-30

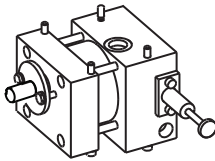

PA-40

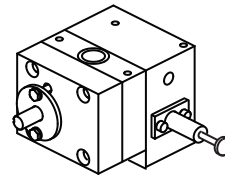

PA-50

#### Circuit Boards, Control Panel and Control Boxes

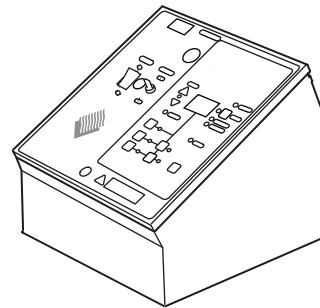
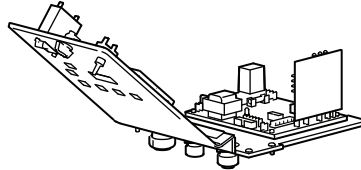
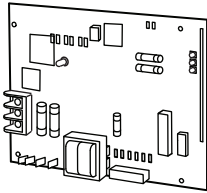

#### Heated Hoses

Regular & Spray  
All lengths 8 - 24 ft.  
#6 & #8 core

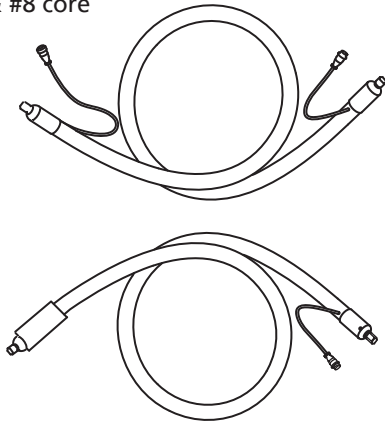

#### Handguns, without nozzles

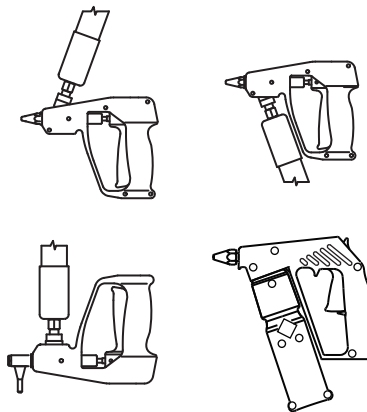

#### Automatic Valve Modules, without nozzles

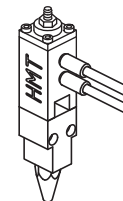

600 & 800 Series



900 Series

NXP Component Exchange List may change without prior notice.  
Call HMT Customer Service for current pricing.

