



In-Line Gun Filter Assembly, 90°

913-050-90, 50 Mesh
913-100-90, 100 Mesh

Instructions

1. Verify that the Filter Nut is threaded back to the Filter Body. Ensure that the Filter Washer and the Filter O-ring move freely and are not resting on the threads.

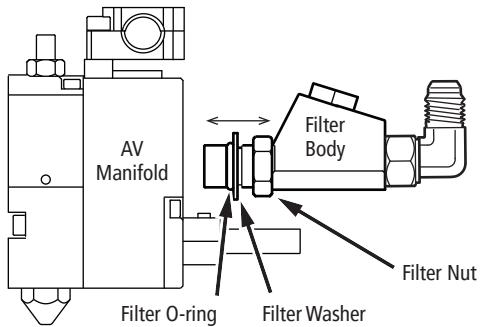

2. Thread the Filter Body into the AV Manifold until tight. Loosen the Filter Body (no more than one turn) to achieve the orientation desired.

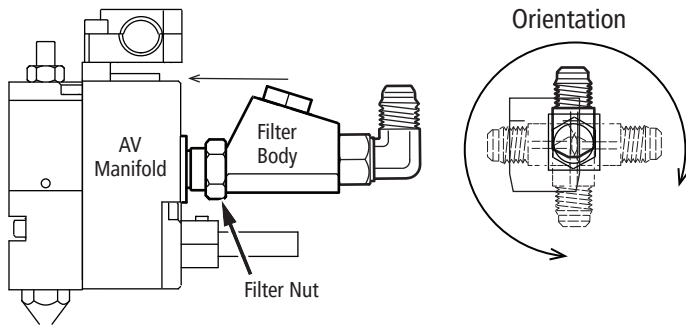

3. Hold the Filter Body in position and tighten the Filter Nut until it rests firmly against the washer. Filter assembly should be tight to the AV Manifold.

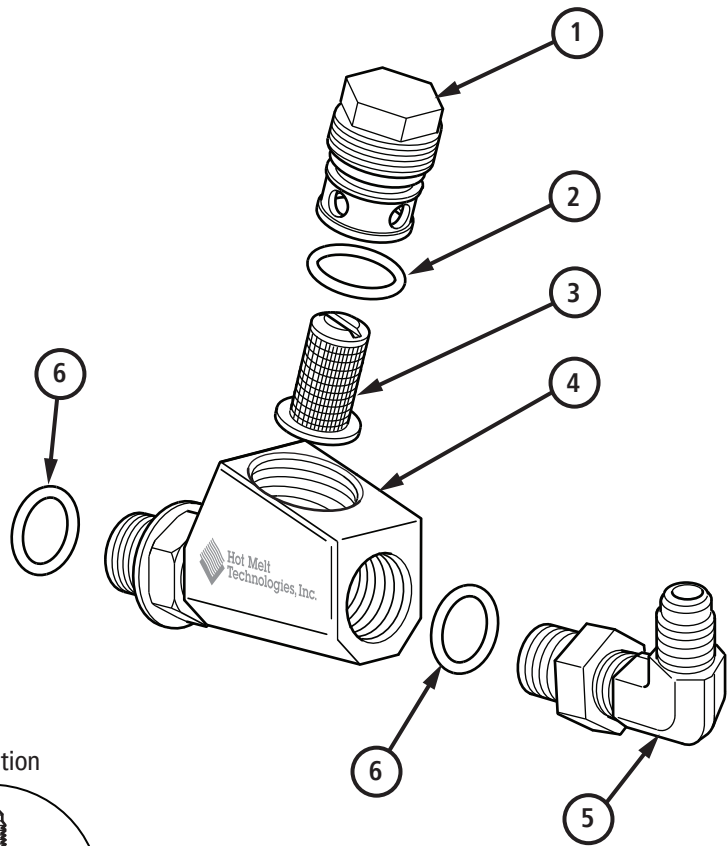
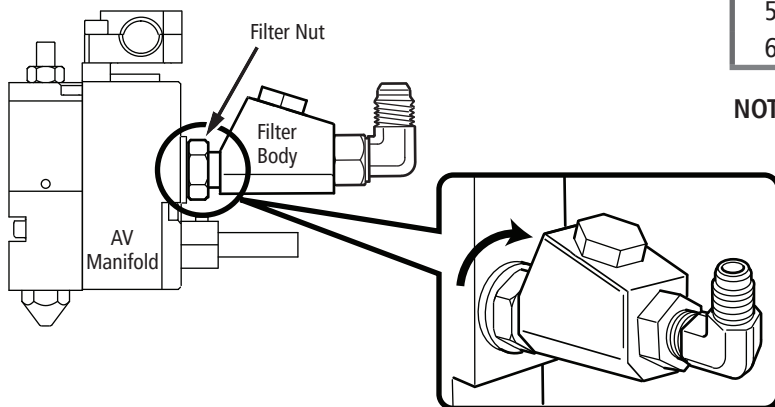

BILL OF MATERIALS			
ITEM	DESCRIPTION	PART NO	QTY
1	Filter Housing	420-110	1
2	O-ring	520-007	1
3a	Filter - 100 Mesh	420-100	1
3b	Filter - 50 Mesh	420-099	1
4	Filter Body Assembly	913-060	1
5	#6 JIC 90° Fluid Fitting	160-045	1
6	O-ring	520-046	2

NOTE: All fittings should be checked and retightened after system has reached set temperature.

