

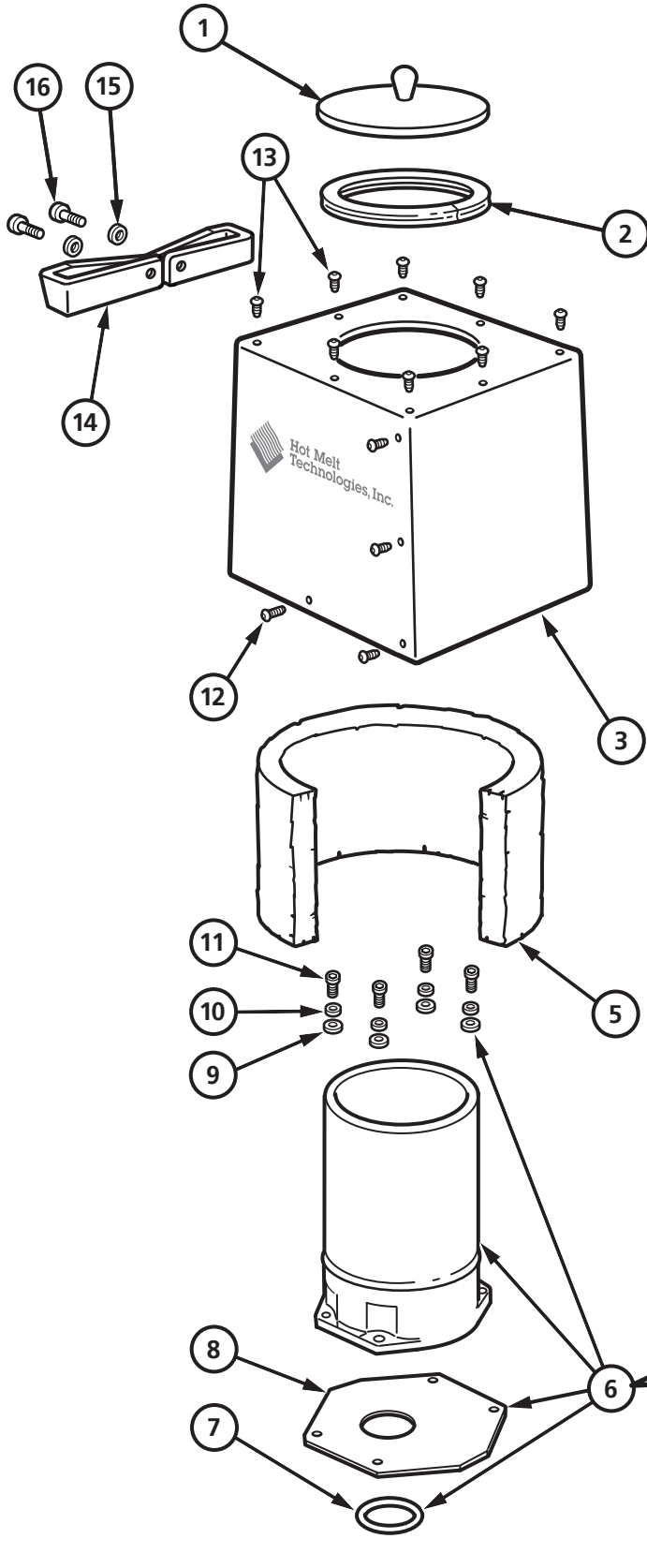

Tank Assembly 12-20 lb, 7" dia



BILL OF MATERIALS			
ITEM	DESCRIPTION	PART NO	QTY
1a	Tank Lid 7"	911-004	1
1b	Tank Lid 7", HSA (optional)	911-019	1
2	Tank Seal 7"	510-015	1
3a	Metal Shroud - 12 lb	911-212	1
3b	Metal Shroud - 17 lb	911-217	1
3c	Metal Shroud - 20 lb	911-220	1
4a	Tank Screen 1/4" Mesh (optional)	420-061	1
4b	Tank Grid Bridge (optional)	420-062	1
5	Tank Insulation	450-003	1
6a	DFS Tank Assembly - 12 lb	911-013	1
6b	DFS Tank Assembly - 17 lb	911-118	1
6c	DFS Tank Assembly - 20 lb	911-021	1
7	O-Ring - Teflon Encapsulated	520-031	1
8	Tank Gasket	510-024	1
9	1/4" Flat Washer	315-007	4
10	1/4" Lock Washer	316-007	4
11	1/4-20x7/8" Socket Head Cap Screw	322-104	4
12	10-32x1/2" Button Head Socket Screw	324-086	2
13	10-32x1/4" Button Head Socket Screw	324-084	14
14	Lid Caddy	330-135	1
15	1/4" Lock Washer	316-007	2
16	1/4-20x1/2" Button Socket Screw	324-137	2

