



PROFLEX® G5/G9 DUAL GRID

High Performance System

220v, 1ph

Standard Features



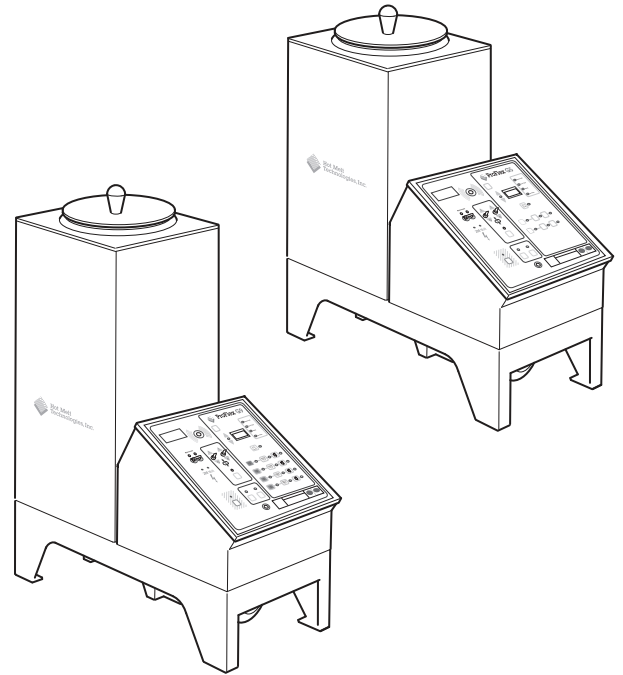

- ▶ Auto-Standby
- ▶ Auto-Off Timer
- ▶ Ready Delay Timer
- ▶ Manual Standby
- ▶ Set Point Limit
- ▶ Front Panel Diagnostics
- ▶ All Zone Ready
- ▶ Temp Readout, °F or °C
- ▶ ±1°F Temp Control
- ▶ Hose/Gun On/Off Control
- ▶ 2 or 4 Hose/Gun Capability
- ▶ Audible Fault Alarm
- ▶ Service Clock
- ▶ Pump On/Off Control
- ▶ Precision Flow Control

Common Options

- ▶ #340-032 Key Lock
- ▶ #934-247 24h/7d Timer
- ▶ #921-011 Steel Cart Assembly
- ▶ #XP-922-221 OEM Interface Cable
- ▶ #XP-922-040 Remote Motor Run Cable
- ▶ #910-055 Pump Pressure Gauge
- ▶ 240v, 3ph available
- ▶ #911-112 Hinged Lid, 10", Installed
- ▶ See Load Alert Page

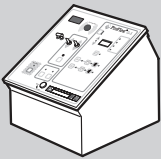

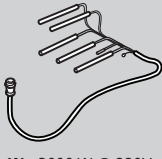
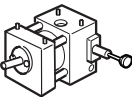
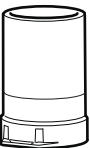
System Configuration

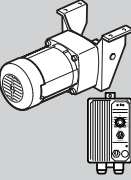
GX XX - XX - 40 - X4 - X				
CONTROL PACKAGE	TANK SIZE	TANK HEATER HARNESS	PUMP	MOTOR
 <p>G5 - 2 hose/2 gun G9 - 4 hose/4 gun</p>	<p>17 lb</p> 	 <p>W - 3000 W @ 220V (17 lb only)</p>	 <p>PA-40</p>	<p>220v, 1ph "Blank"</p> <p>CONSTANT SPEED</p> <p>M - 85 RPM, 1/6 HP F - 113 RPM, 1/3 HP K - 170 RPM, 1/3 HP</p>
	<p>50 lb</p> 	<p>85 lb</p> 	<p>WS - 3000 W @ 220V (50 and 85 lb only)</p>	 <p>VARIABLE SPEED</p> <p>A - AC 0-125 RPM</p>