

ProFlex® G5HD

SERVICE MANUAL

Your System Configuration

Temperature Controls

Microprocessor - HD

2 Hoses/2 Guns

Single Motor/Pump

Voltage Requirements

220 VAC, Single Phase, 40 A

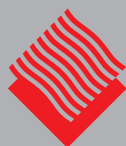

**Hot Melt
Technologies, Inc.**

No One Puts It Together Like HMT®

1723 W. Hamlin Rd | Rochester Hills, MI 48309

248.853.2011 | www.hotmelt-tech.com



Intended Use

Benchmark® and ProFlex® adhesive melters and components are designed to melt and pump thermoplastic hot melt adhesives and sealants. Any other use is considered to be unintended. Hot Melt Technologies (HMT®) will not be liable for personal injury or property damage resulting from unintended use. Intended use includes the observance of HMT safety instructions. HMT recommends obtaining detailed information on the hot melt materials being used.

- ▶ The product is only intended for use in industrial applications and may only be used to melt and pump thermoplastic hot melt adhesives (e.g. EVA, PSA, APO, Polyamid).
- ▶ The product may only be installed, assembled, commissioned, operated, maintained, repaired, de-commissioned and disposed of by trained personnel.
- ▶ The product may only be operated with compatible original components and original accessories from Hot Melt Technologies Inc.
- ▶ The product is to be used exclusively for the purpose described herein and within the limits defined in this document. The product must not be modified with respect to its structure or its safety features without the written consent of Hot Melt Technologies. No changes to the software or hardware of HMT products are permitted. Only use original spare parts, original accessories or standard parts that have been approved by HMT.

The instructions are part of this product. No applications other than those described in the instructions are permitted.

Improper Use

Examples of misuse of the product include:

- ▶ Melting and pumping of unsuitable adhesives (e.g. PUR-Polyurethane hot melt adhesives)
- ▶ In defective condition
- ▶ With electrical cabinet open
- ▶ With the tank lid open
- ▶ Melting and pumping materials which, when under vacuum or pressure, can pose a health hazard or endanger safety in the workplace (e.g. solvents, explosive or highly flammable materials)
- ▶ Cleaning the product with highly flammable materials (e.g. solvents)
- ▶ Use in environments that require cleaning of the product with jets or sprays of water
- ▶ Processing of food

Residual Risks

In the design of the Benchmark and ProFlex systems, every measure was taken to protect personnel from potential danger. However, some residual risks can not be avoided:

- ▶ Risk of burns from hot material
- ▶ Risk of burns when filling the tank, from the tank lid, and from the hose and gun exposed metal surfaces.
- ▶ Risk of burns when conducting maintenance and repair work for which the melter or components must be heated up.
- ▶ Material fumes may be hazardous. Always avoid direct inhalation.



Table of Contents	3
Safety & Set Up	4-5
Operating Instructions	6-14
Front Panel Controls	6-7
Settings Menu	8
24/7 Timer.....	9-13
Ground Fault Equipment Protection & Open Loop Fault	14
Components	15-16
Front Panel.....	15
Fuse & Relay Chart.....	16
Electrical	17
Schematic	17
Warranty Information	18





STOP



If incorrectly used, this machine can cause severe injury. Those who use and maintain the machine should be trained in its proper use, warned of its dangers, and should read the entire manual before attempting to set up, operate, adjust or service the machine.

WARNING

- ▶ Do not allow the pump motor to stall. A prolonged stall may damage the motor and other components.
- ▶ Do not connect or disconnect electrical connectors, or remove components, with the power on. This will prevent arcing of electrical contacts and possible failure of components.
- ▶ Always close and secure the control panel access cover to protect internal electrical components.
- ▶ Always operate the system with the tank full and lid on.
- ▶ Prior to dismantling, assembly, or adjustment of certain service parts (hose/gun fittings, pump assemblies, etc.), the part(s) being serviced should be preheated to reduce the chance of stripping threads or ruining components.
- ▶ Working on or around hot melt adhesives and equipment can cause severe burns.
- ▶ Use eye protection, gloves and protective clothing while operating and/or servicing hot melt equipment.
- ▶ Before installing any hot melt equipment, determine proper electrical requirements per all applicable codes.

At Hot Melt Technologies, we pay special attention to the needs of operators and service personnel when designing equipment, but molten hot melt adhesives are dangerous and can cause severe burns. Extreme care must be exercised to insure personnel safety.

Fire, explosion, personal injury, property, and/or equipment damage can result if the material(s) used in or around any hot melt adhesive supply unit are toxic, heat, or fire sensitive. Always read the manufacturer's recommended use guidelines.

All HMT units are equipped with over temperature protection as a necessary safety device. Run-away heating can cause hot melt materials to exceed their flashpoint.



Prevent Serious Equipment Damage

Protect your hot melt equipment by installing a GFEP (Ground Fault Equipment Protector) device in your distribution panel.

HMT® recommends that hot melt systems be protected from unintended line-to-ground currents by installing an appropriate ground fault equipment protection (GFEP) device. Contact HMT Technical Service & Support or a qualified electrical contractor for more information. When installing a GFEP device always comply with local electrical codes.

LEGEND: SAFETY SYMBOLS

	Electric Shock Hazard: Line Voltage Present with Machine Power Off. Risk of electrical Shock or Burn
	Disconnect Power Before Servicing
	Consult Service Manual
	Warning/ Caution: Used to draw attention to Hot Surface Warnings, Over Temp Alarms, Hose Routing Practices, and other safety notifications.
	Hot Surface: Surface and surrounding area may be hot. Exercise extreme caution and utilize proper Personal Protective Equipment (PPE).

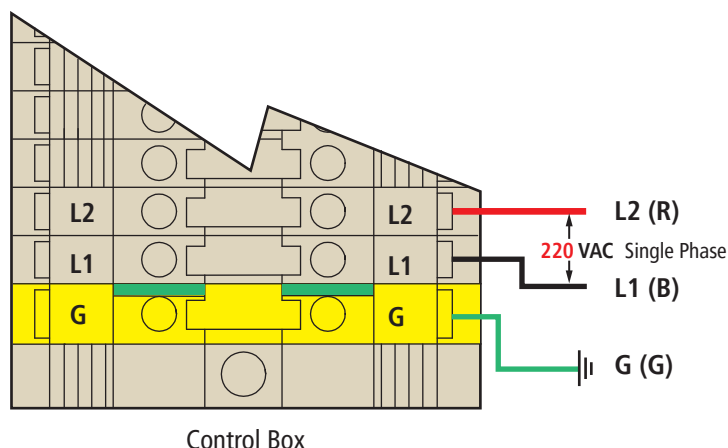

Before Using Your Hot Melt System

It is your responsibility and obligation to make sure your system:

- ▶ Has been properly installed off the floor and on a steady, level work surface away from combustible materials.
- ▶ Has been located in such a way that the controls are away from the operator and that the control panel is securely closed at all times.
- ▶ Is the right capacity system for the intended use.
- ▶ Is connected to the proper power supply. (See Below).
- ▶ Is only used to do what a hot melt system is designed to do.
- ▶ Is not used by anyone unable to operate it properly.
- ▶ Is used in an area where the room temperature does not fall below 65 °F.
- ▶ Is used in an area which is free from blowing air caused by cooling fans, open doors or windows.

Basic Electrical Power Connections

For 220 VAC Operation

- ▶ A fused 40 A 220 VAC electrical supply is required. Performance problems will occur with voltages less than 208 VAC or greater than 240 VAC.
- ▶ Total amperage draw will depend on the final system configuration; number of hoses & length, guns, accessories, etc.
- ▶ Do not allow the system to share the same circuit with other electrical items. A dedicated supply is recommended.
- ▶ Do not use an extension cord.
- ▶ If you change the configuration of your system in any way that may affect the electrical requirements (ex. add a gun, longer hose, automate, etc.) call HMT Technical Service & Support at 248-853-2011 for assistance.





Front Panel Controls

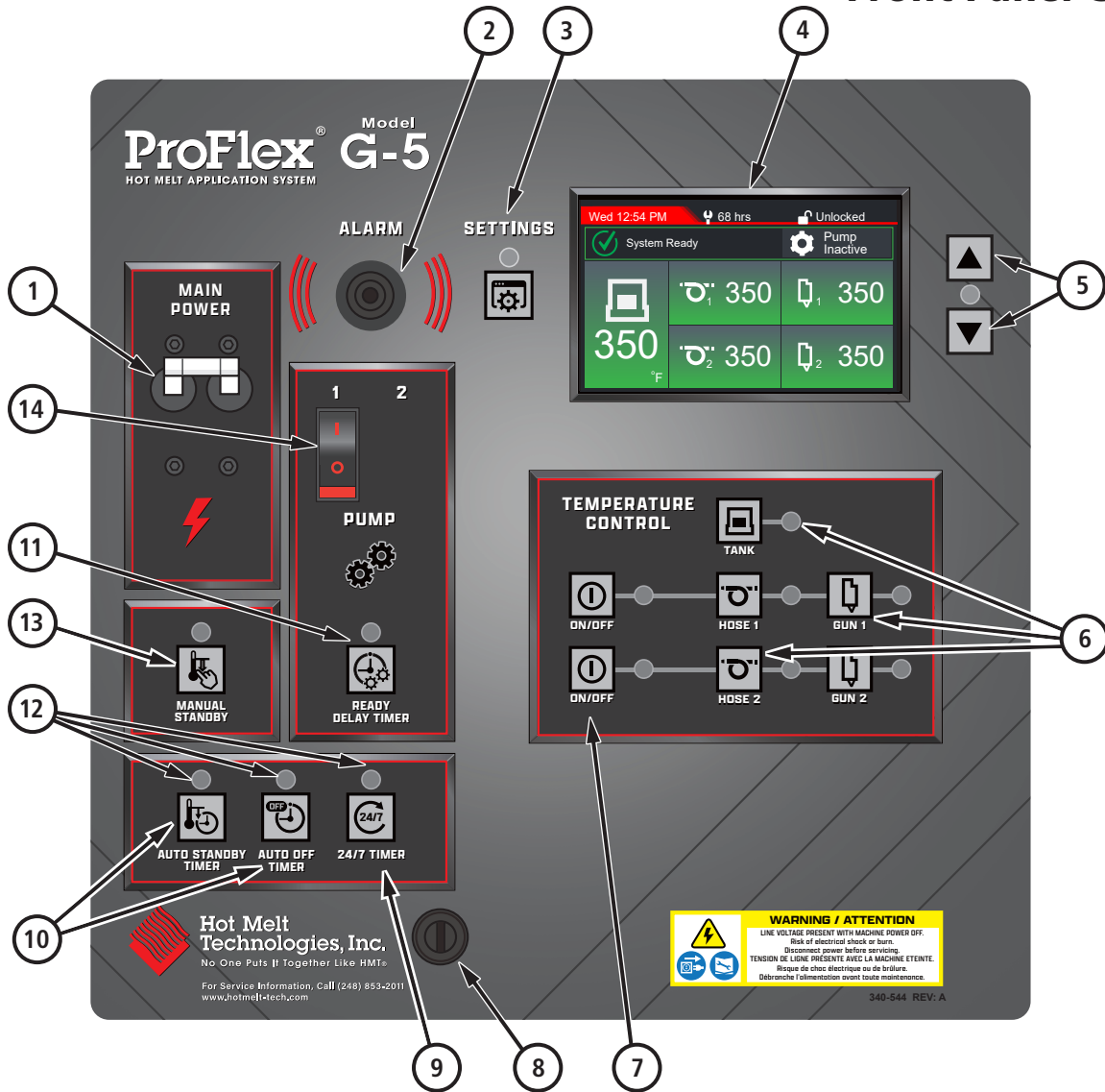

- ① **Main Power Switch:** Turns the system "ON" or "OFF."
- ② **Audible Over Temp Alarm:** Sounds when a zone is in Over Temp.
- ③ **Settings:** With the system Unlocked, press 'Settings' button to view and adjust system settings. System settings include Day & Time, Timers, High Limit, Standby Setback, All Zones Ready, °F or °C, and Display Brightness. When the system is Locked, press and hold the 'Settings' button to view system settings. See page 8 for additional information about Settings.
- ④ **High Definition System Display:** The HD display is not a touch screen. Use the face panel buttons to interact with the HD display. The home screen displays the day of the week and current time, service hours, unlocked or locked, pump ready status, pump trigger status, and the actual temperatures of the tank, hose, and gun zones.
- ⑤ **Arrow Buttons and Set Mode LED:** The '▼' and '▲' Arrow Buttons enable users to adjust temperature set points and modify system settings. When adjustment is possible, the Set Mode LED will flash orange, indicating the availability of the Arrow Buttons for use.

- ⑥ **Zone Temp and Status Display Buttons and LEDs:** Press and hold any zone button (e.g. Tank, Hose, Gun, Grid) to toggle the corresponding setpoint display screen. With the system Unlocked, the Arrow Buttons can be used to adjust the zone temperature setpoint. When the system is locked, the zone temperature setpoint and status are displayed, but cannot be adjusted.

Zone LEDs

- Green:** If the LED is green, the corresponding zone is ready—within 25°F (14°C) of the temperature setpoint.
- Orange (Pulsing):** The corresponding zone is heating and is more than 25°F (14°C) below the temperature setpoint
- Orange (Solid):** The system is in Standby
- Red (Solid):** The corresponding zone is disconnected or the RTD sensor has faulted.
- Red (Flashing):** An Over Temp fault has occurred in the corresponding zone.
- OFF (No Light):** The zone has been turned off.



Front Panel Controls

ProFlex® G5HD

- 7 Hose/Gun ON/OFF Buttons:** To prevent adhesive degradation in hose and gun zones that are not being used, the Hose/Gun On/Off Buttons turn the power ON or OFF to each hose/gun group individually. The indicator light illuminates accordingly.
- 8 Front Panel Lock:** Used to secure the front panel. To enhance the system's tamper resistance, a key lock option is available.
- 9 24/7 Timer:** The 24/7 Timer is simple and easy to use and can be scheduled to automatically turn the system on prior to production to ensure that the adhesive is adequately melted and ready for operation to meet the demands of your application. At the end of the workday or during extended idle periods, the system can be programmed to shut down, minimizing energy consumption and preventing unnecessary adhesive degradation until it is needed again.

To review scheduled ON and OFF events, press the '24/7 Timer' button. To configure a schedule, navigate to the 'Settings' menu and select the 'Timers' submenu.

- 10 Auto-Off and Auto Standby Timer:** ProFlex® systems are equipped with Auto-Off and Auto Standby Timers to help prevent adhesive degradation and ensure the equipment is safely powered down or in standby mode during extended periods of unexpected inactivity. Examples:
- ▶ Leave for the day and someone forgot to turn off the hot melt machine.
 - ▶ The 24/7 timer turns the system on Monday morning – but it's a holiday and no one is working.
 - ▶ The system turns on but is left unattended because production is not running.

In either case, if the system is left unattended (from 1–5 hours), it can automatically turn off; or go into Standby mode; or go to Standby first, followed by turning off. To cancel an active Auto-Off or Auto-Standby Timer press the corresponding timer button. When prompted to cancel, use the '▼' and '▲' arrow buttons to highlight 'Yes', then confirm by pressing the 'Settings' (OK) button.

- 11 Pump Ready Delay Timer:** With all hot melt systems, it is important not to run the pump until it has reached a safe operating temperature. At HMT, all our pumps stay inactive until they achieve a temperature at or near the temperature of the glue in the melt tank.
- However, when using a high viscosity adhesive in a high volume, automated application, you may want a little more melt time in the tank to assure uninterrupted flow.
- The pump ready delay timer can be programmed to add between 5 and 60 minutes of tank melt time before the pump is ready to run. To cancel an active Ready Delay, press the 'Ready Delay Timer' button. When prompted to cancel, use the '▲' and '▼' arrow buttons to highlight 'Yes', then confirm by pressing the 'Settings' (OK) button.
- 12 Timer LEDs:** A flashing green LED indicates that the timer has been enabled and is currently active. A solid green LED indicates that the timer has been programmed and is enabled but is not currently active. If a timer LED is Off, then the timer is disabled.

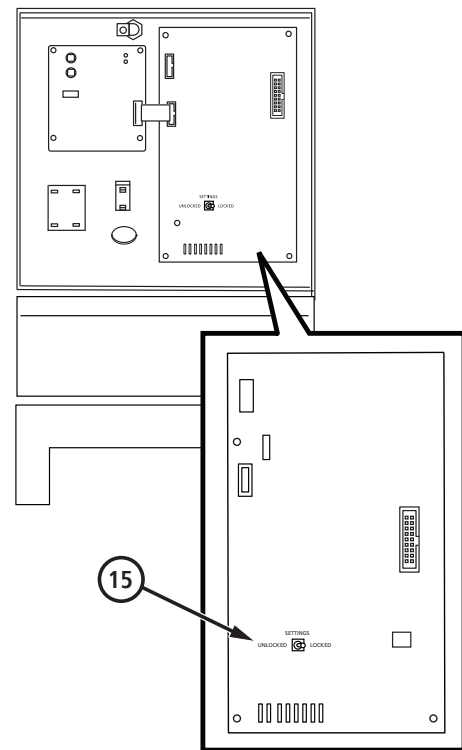

- 13 Manual Standby:** All Hot Melt adhesives and sealants degrade when left unattended at full temperature. This degradation takes place in every wetted part — tanks, hoses, and guns. The solution? Turn the system off when not in use or put it in standby mode when unattended for lengthy periods.

ProFlex® systems are equipped with a manual standby switch which, when activated, automatically reduces the temperature set point of the tank, hoses and guns. The standby temperature reduction can be programmed between 20% and 70% of the set point.

- 14 Pump ON/OFF Switch:** The pump will only operate when this switch is ON, the pump is ready, and a trigger input is provided.

- 15 Set Lock:** The Set Lock feature ensures system settings and temperature setpoints remain secure, preventing unauthorized adjustments. The system can be Locked or Unlocked using the toggle switch located on the back of the display board.

To modify system settings or adjust temperature setpoints, the Set Lock toggle switch must be set to the Unlocked position. When the system is Locked, all adjustments to settings and zone temperature setpoints are restricted. The HD system display will indicate the Set Lock status, accompanied by an open or closed padlock icon in the upper-right corner.



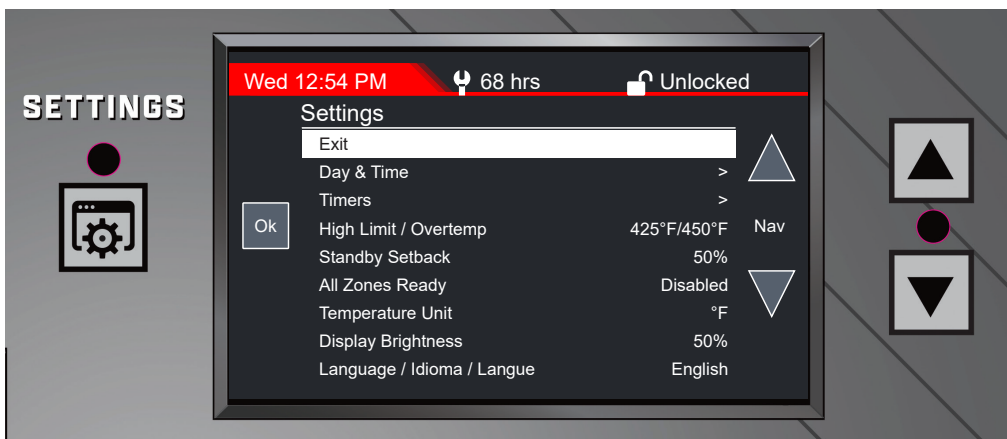

Settings Menu: The Settings Menu provides access to a list of system settings. With the system unlocked, users can navigate the menu using the '▼' and '▲' buttons, while the 'Settings' (OK) button functions as a selection or confirmation tool. When locked, the Settings Menu displays a list of the system settings.

Day & Time: Select 'Day & Time' to configure the current day of the week and time of day. Accurate Day & Time settings are essential for the proper operation of the 24/7 Timer.

Note: Time does not automatically adjust to daylight savings time.

Timers: Select 'Timers' to view and configure timer settings.

Auto-Standby: Automatically places all zones in Standby after a duration of inactivity. To enable Auto-Standby, choose a duration from 1 to 5 hours. To disable Auto-Standby, select 'Disabled'.

***Auto-Off:** Automatically turns all zones OFF after a duration of inactivity. To enable Auto-Off, choose a duration from 1 to 5 hours. To disable Auto-Off, select 'Disabled'.

**Note: When both the Auto-Standby and Auto-Off timers are enabled, the system will first enter standby mode after the programmed period of inactivity. Once in Auto-Standby, the Auto-Off timer will start, and all zones will turn off automatically if the system remains inactive.*

Ready Delay Timer: Delays pump operation and the system ready output signal from 5 to 60 minutes. To enable the Ready Delay Timer, choose a duration from 5 to 60 minutes. To disable the Ready Delay Timer, select 'Disabled'.

24/7 On-Off Timer: Set a system On/Off schedule by time and day of the week using the 24/7 On-Off Timer. See 24/7 On/Of Timer instructions on pages 9-13 for programming information.

High Limit/Overtemp: All Hot Melt adhesives and sealants have a defined application temperature range with a recommended upper limit. To promote safe operation and minimize adhesive degradation, the High Limit feature allows the Set Point for all zones to be restricted to this maximum threshold. The High Limit is adjustable between 250°F (120°C) and 475°F (245°C), with Overtemp automatically set 25°F (14°C) above the selected High Limit.

Standby Setback: Adjust the temperature setback during Manual and Automatic Standby from 20% to 70% of the temperature setpoint. The default setting is 50%.

All Zones Ready: Enable the All Zones Ready feature to prevent pump operation until all active zones (e.g., Tank, Hose, and Gun) reach their respective Ready Temp, and to trigger an alert if a hose or gun zone drops more than 25°F (14°C) below the setpoint. This function is especially valuable in automated applications with limited visibility, as it interrupts the system ready signal and shuts off the pump when a significant temperature drop occurs. By preventing adhesive application at insufficient temperatures, it helps reduce material waste and maintains product quality. When disabled, the pump can be activated when the Tank has reached Ready Temp.

Temperature Unit: Zone temperatures can be displayed in either Fahrenheit (°F) or Celsius (°C).

Display Brightness: Adjust the display brightness from 10 to 100%.

Language/Idioma/Langue: Select the language for the user interface.



ProFlex® G5HD – 24/7 Timer

The 24/7 On-Off Timer is used to schedule system On and Off times. This timer overrides both the Auto Off and Auto Standby Timers, ensuring the system shuts down according to its schedule regardless of those settings. To configure this feature, press the 'Settings' button and use the '▼' and '▲' buttons to navigate to the 'Timers' sub-menu and press 'Setting' (OK). Within the 'Timers' sub-menu, navigate to '24/7 Timer' using the same buttons, and press the 'Settings' (OK) to configure the 24/7 Timer. Verify that the system's date and time are accurate to ensure expected performance.

Upon initial setup of the 24/7 On-Off Timer, the Program Overview & Day Select screen will appear. This interface allows users to designate specific days for scheduling On/Off events. If the 24/7 On-Off Timer has an existing On-Off schedule, the Enable/Disable 24/7 On-Off Timer screen will appear. Simply select 'Re-Program' to access the Program Overview & Day Select screen.

Program Overview & Day Select Screen

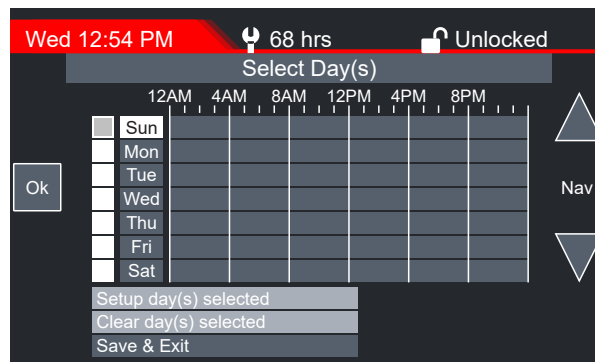

To establish an ON/OFF schedule:

1. Use the '▼' and '▲' buttons to toggle through the days of the week. Press 'Settings' (OK) to select or deselect the day(s) to configure. The white box next to the selected days will change to green.
2. To program the selected days, choose 'Setup Day(s) Selected' and press 'Settings' (OK). Pre-existing schedules can be erased by selecting 'Clear Day(s) Selected' and pressing Settings (OK).





On/Off Event Setup Screen

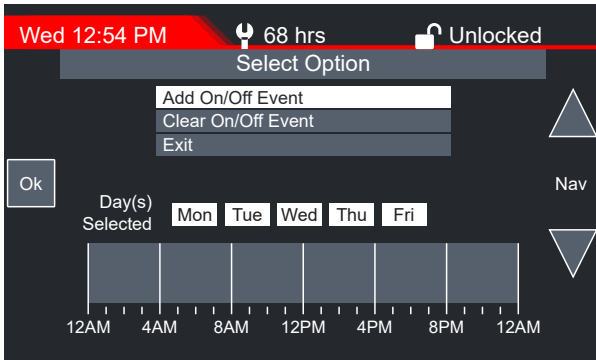

3. To program On/Off events for the selected day(s), navigate to 'Add ON/OFF Event' and press 'Settings' (OK). Use the '▼' and '▲' buttons to select an ON time and press 'Settings' (OK). Repeat this process to select an OFF time. A green bar will indicate active System ON periods displayed on the time scale, while gray segments represent OFF periods.
4. Multiple On/Off events can be scheduled during a day. To schedule additional On/Off events during the day(s) selected, repeat step 3.
5. To clear all programmed events and start over, choose 'Clear ON/OFF Events' and press 'Settings' (OK).
6. When finished configuring the selected days, choose 'Exit' to return to the Program Overview & Day Select screen.

Program Overview & Day Select Screen with On/Off Schedule

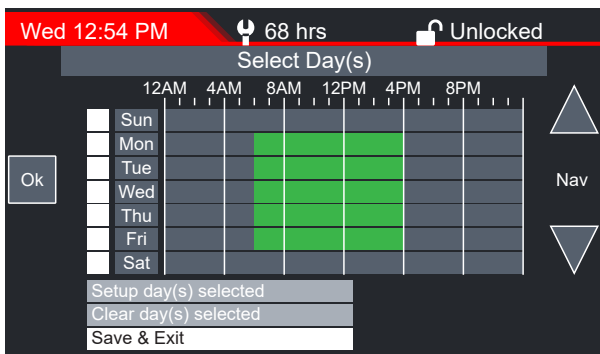

7. The Program Overview & Day Select screen has been updated to display scheduled On and Off events. Repeat Steps 1 through 6 to schedule additional events or edit existing events. Use the '▼' and '▲' buttons to navigate to 'Save & Exit' and press 'Settings' (OK) to save the On/Off schedule.

Enable/Disable 24/7 On-Off Timer Screen

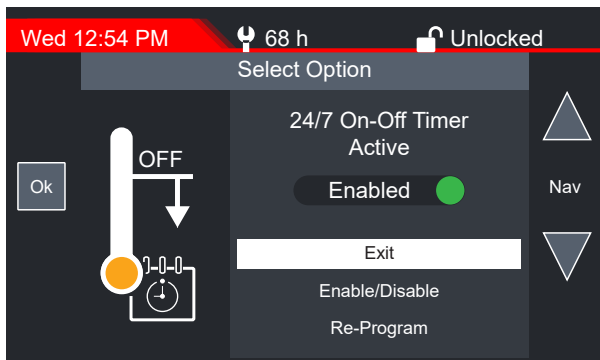

8. To activate the scheduled On/Off events, the 24/7 On-Off Timer must be enabled. To switch between enabled and disabled, use the '▼' and '▲' buttons to navigate to 'Enable/Disable,' then press 'Settings' (OK) to enable or disable the timer. When the 24/7 Timer is enabled, the LED indicator above the corresponding button will illuminate green.
9. To configure additional days or to edit existing ON/OFF events, select 'Re-Program'.
10. Choose 'Exit' to return to the 'Settings' menu.



24/7 Timer

ProFlex® G5HD

24/7 Timer Status Screen

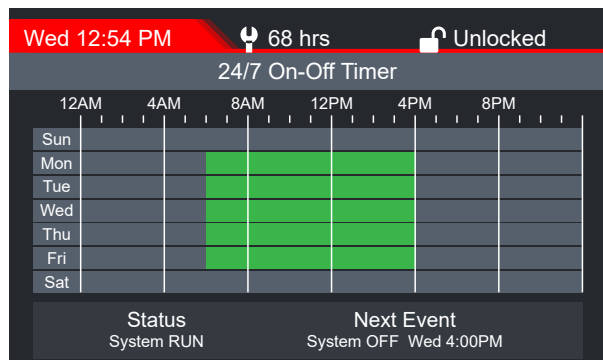

11. To see an overview of the scheduled On/Off events, press the 24/7 timer button on the ProFlex® face panel. A green bar is displayed where the system is ON and gray is shown where the system is OFF.

Override the 24/7 Timer during Off

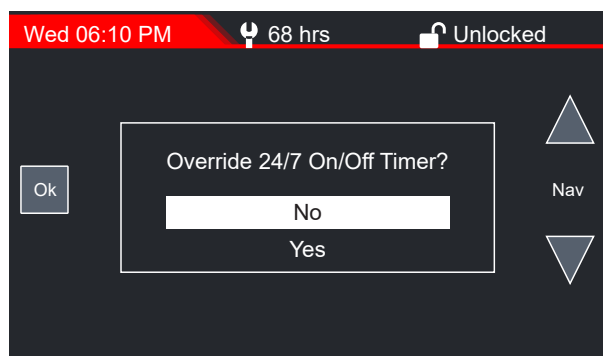

12. To override the 24/7 timer during a scheduled OFF, press the 24/7 timer button on the face panel, select 'Disable', and press 'Settings' (OK). To resume the 24/7 timer schedule, simply cycle the system power OFF and ON.

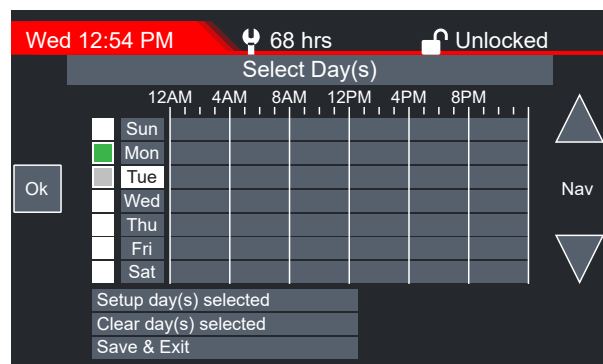

Example – Programming the 24/7 Timer

Production begins at 7AM and ends at 4 PM, Monday through Friday. Setup a schedule to turn the system on an hour before production begins to ensure enough adhesive has melted, and turn the system off at 4PM for the evening.

Step 1. Use the '▼' and '▲' buttons to toggle through the days of the week to Monday and press 'Settings' (OK) to select Monday. Repeat this step for Tuesday, Wednesday, Thursday, and Friday.

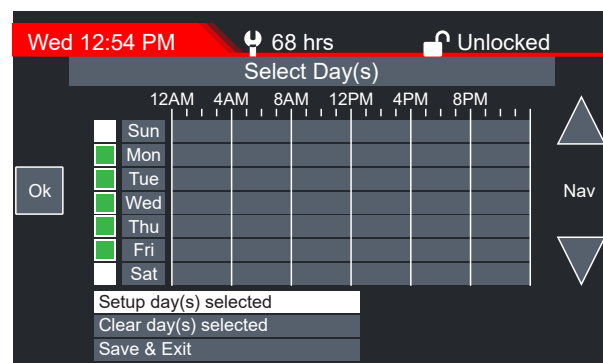

Step 2. Verify that Monday through Friday is selected by noting the green box next to the corresponding day of the week. If all five days are selected, navigate to 'Setup Day(s) Selected' and press 'Settings' (OK).

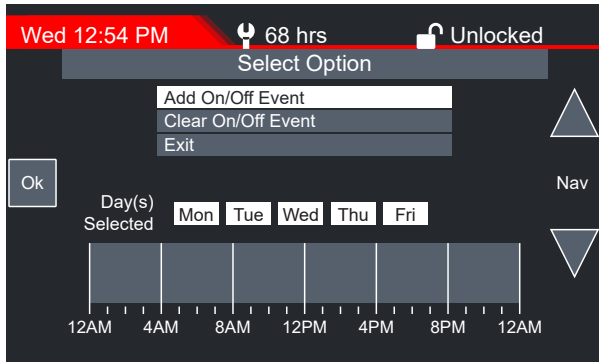

Step 3. The ON/OFF Event Setup screen will appear showing the days selected for programming. Select 'Add On/Off Event' to set up the system ON time for the days selected.

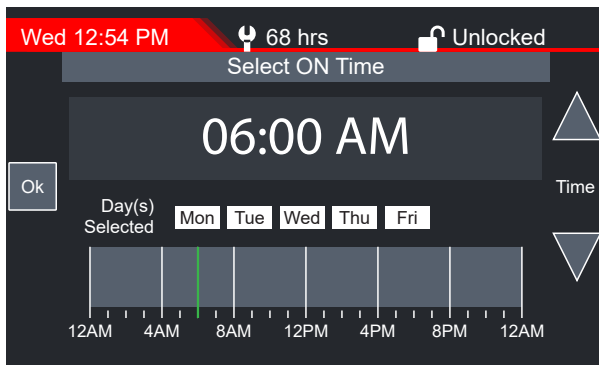

Step 4. Since production starts at 7AM, and the system needs to be ready for operation, use the '▼' and '▲' buttons to navigate to 6:00 AM and press 'Settings' (OK) to select 6:00AM as the ON time.

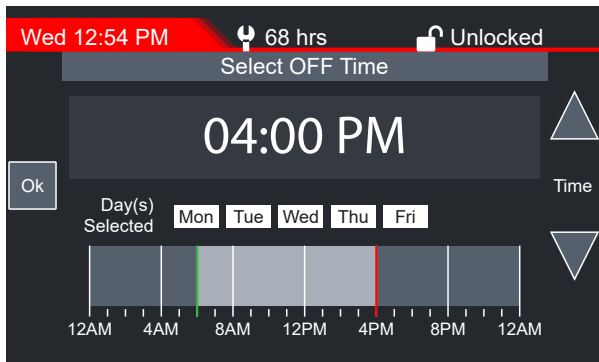

Step 5. Now select an OFF time by using the '▼' and '▲' buttons to navigate to 4:00PM and press 'Settings' (OK) to set 4:00PM as the OFF time.

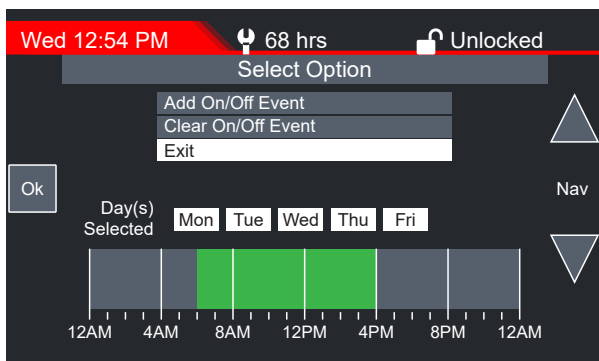

Step 6. Review the time scale. If the On/Off schedule is correct, use the '▼' and '▲' buttons to navigate to 'Exit' and press 'Settings' (OK). If the schedule is incorrect, select 'Clear On/Off Events' and start again at Step 3.



24/7 Timer

ProFlex® G5HD

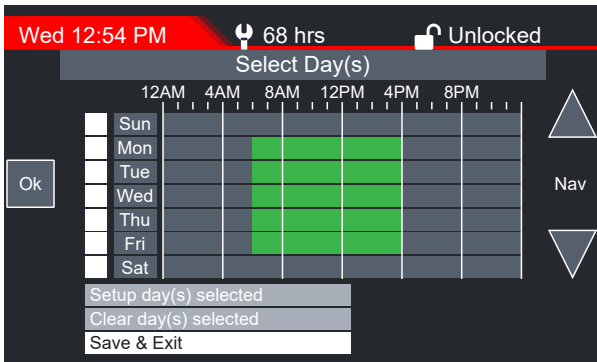

Step 7. After selecting 'Exit', the 'Select Days' screen will appear showing an overview of the On/Off schedule for the week. To move forward with this program, select 'Save & Exit'.

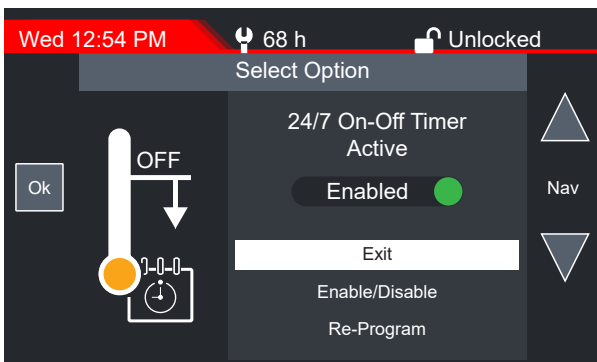

Step 8. Verify that the slider below '24/7 On-Off Timer' is in the Enabled position, and exit. Note that the LED above the 24/7 Timer button is either green or flashing green if the timer is enabled.

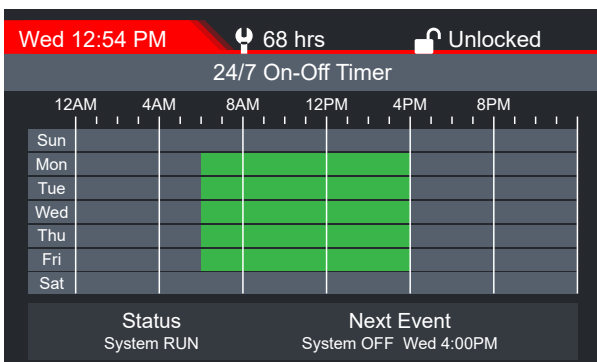

Step 9. The system On/Off schedule can be viewed by pressing the '24/7 Timer' button on the ProFlex® face panel.



ProFlex® G5HD

Ground Fault Equipment Protection & Open Loop Fault

Sensor Fault Indicator

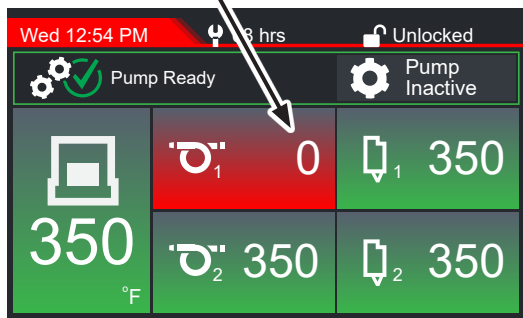

This adhesive dispensing system is equipped with a Ground Fault Equipment Protector (GFEP) on the the hose zones and is designed to protect against an unintended ground fault.

If a ground fault is detected in a hose zone,

- ▶ The GFEP will remove power from the faulted zone.
- ▶ A Sensor Fault will be displayed on the HD System Display.
- ▶ The GFEP Indicator LED for the faulted zone will turn on.
- ▶ The GFEP will remain faulted until the source of the fault is removed AND the Main Power is cycled.

If a ground fault is detected during operation, contact HMT Technical Service & Support for assistance.

Ground Fault Equipment Protector (GFEP)

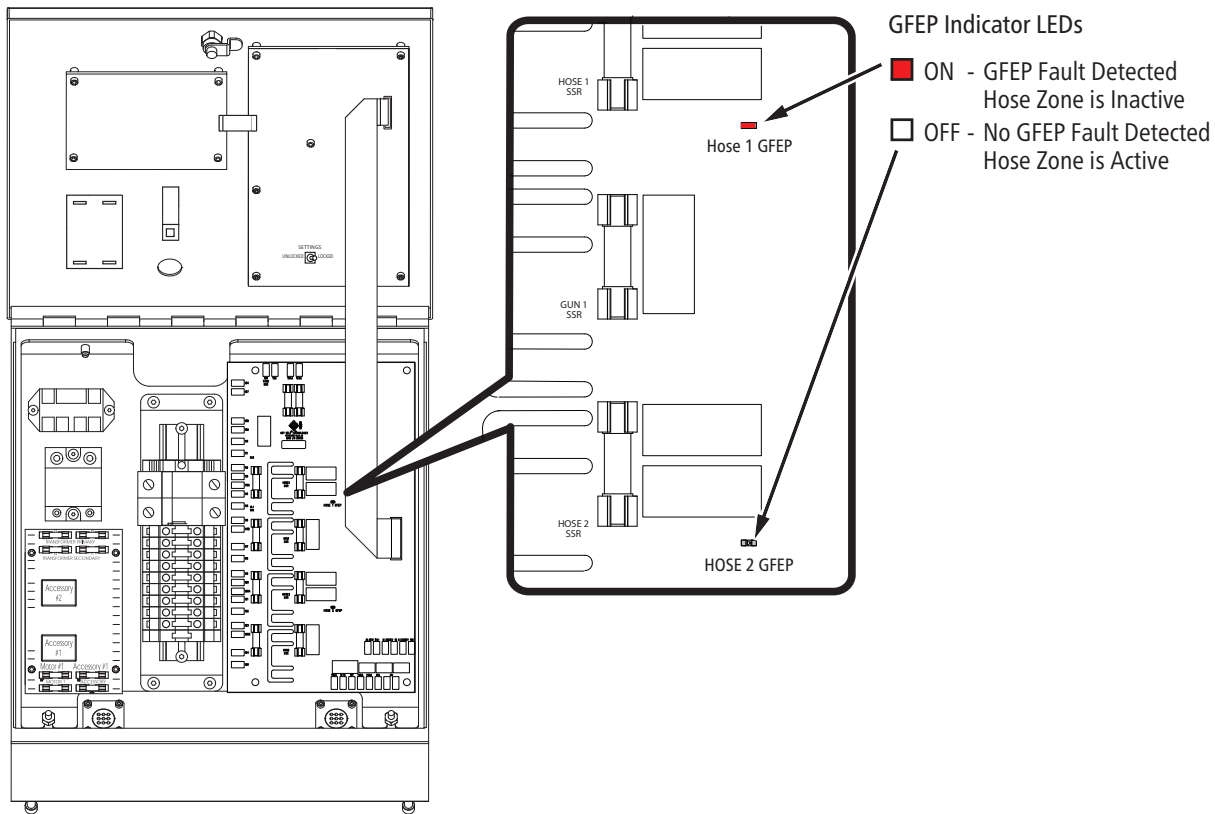

Open Loop Fault (Tank Zone)

This fault is a safety feature that is provided with all ETL approved ProFlex systems; it occurs when the tank zone has been attempting to heat, but the temperature has not increased for ten (10) minutes. If this fault occurs, the tank zone on the High Definition System Display will turn red and display a temperature of 0° and a notification will appear on the display stating, "Tank Open Loop Fault". The tank zone will no longer heat until the following procedure is executed.

Address the Issue

1. Ensure that the tank RTD is properly installed in the heater plate (Caution: Tank, Pump, RTD, and Heater Plate may be Hot! Use proper PPE).

2. Power Off the system, disconnect from main power, and check the Tank Fuses and Transformer Fuses. Replace if necessary.

Clear the Open Loop Fault

1. Turn the Main Power OFF and then back ON.
2. With the Main Power back ON, a notification will be displayed providing an option to 'Reset' the Open Loop Fault or 'Cancel'. 'Reset' will clear the fault and resume normal operation, and 'Cancel' maintains the fault condition preventing the Tank zone from heating.



Front Panel

ProFlex® G5HD

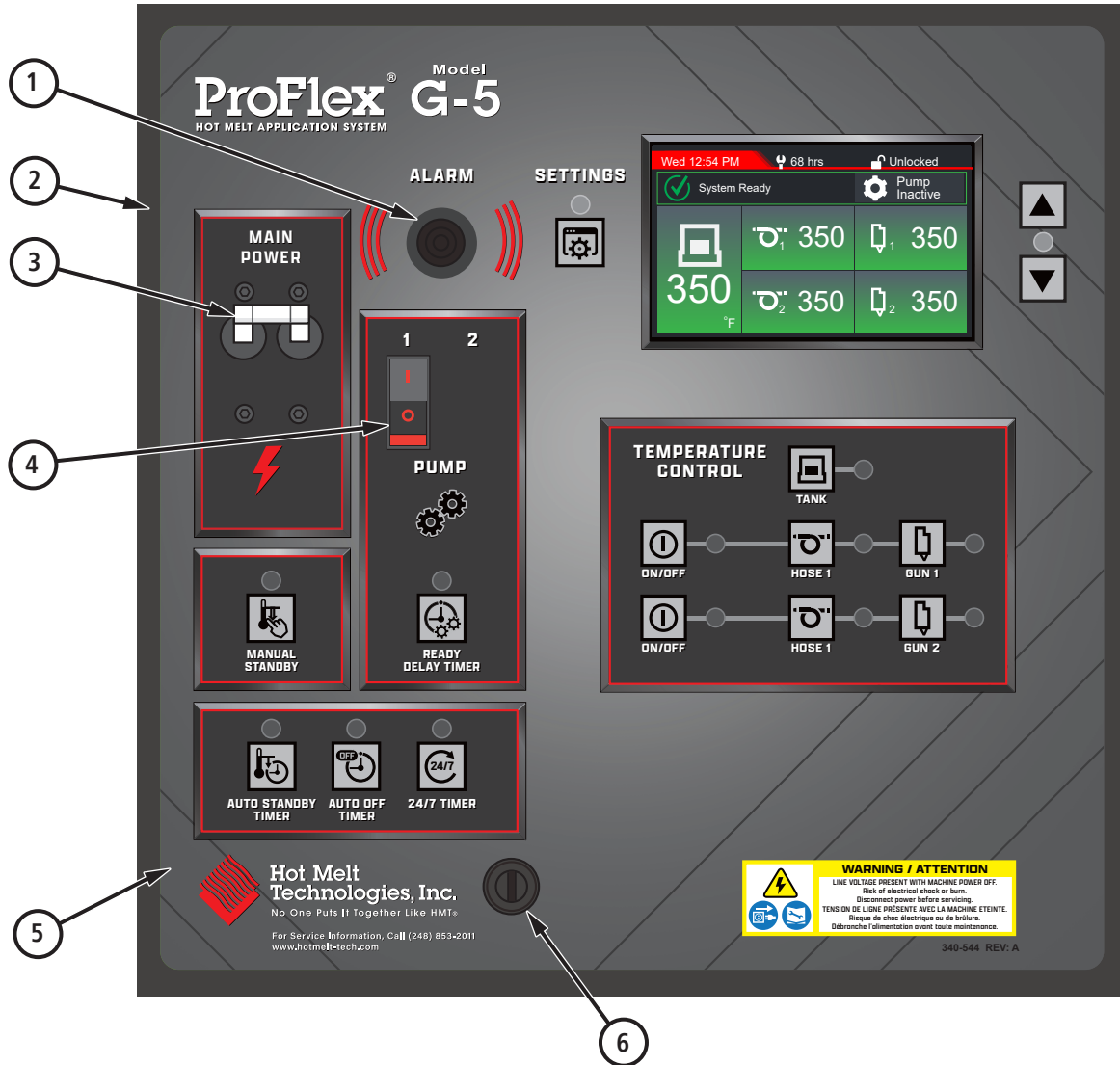

BILL OF MATERIALS			
ITEM	DESCRIPTION	PART NO	QTY
1	Over Temp Alarm	243-006	1
2	Control Box Assembly	934-571	1
3	Main Power Switch, 40 A, 220 VAC	211-017	1
4	Pump Switch, 10 A	211-022	1
5	Decal	340-544	1
6a	Front Panel Latch, Non-Locking	340-030	1
6b	Front Panel Latch, Locking (Optional)	340-032	1



Fuse & Relay Chart

Single Motor

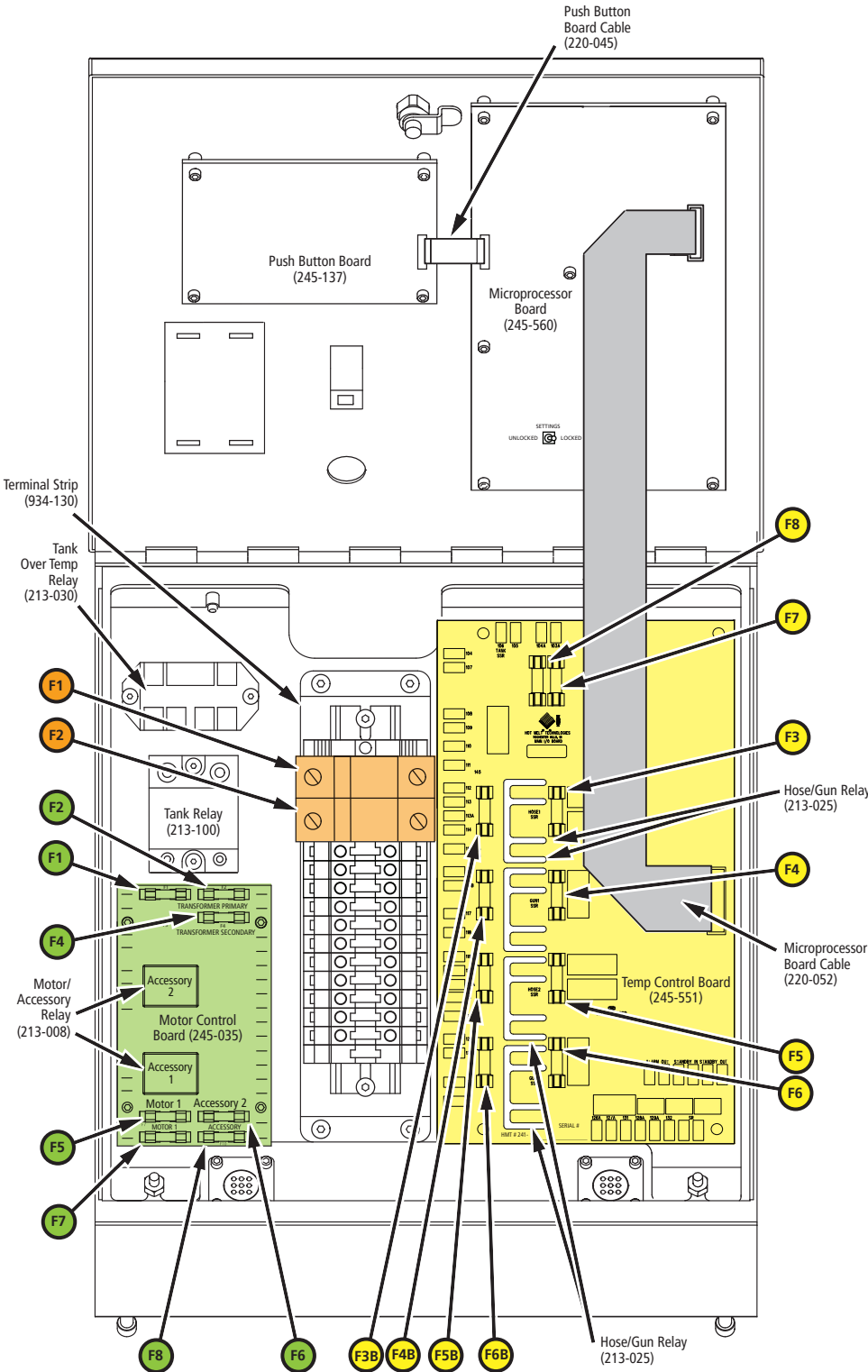

TANK HEATER FUSE			
ITEM	DESCRIPTION	REPLACE WITH	PART NO
F1/F2	2400 W	20 A, 600 VAC (KLKR)	214-320
	3000 W	20 A, 600 VAC (KLKR)	214-320
	4800 W	30 A, 600 VAC (KLKR)	214-330
	6000 W	35 A, 600 VAC (KLKR)	214-335

TEMP CONTROL BOARD			
ITEM	DESCRIPTION	REPLACE WITH	PART NO
F3/F3B	Hose up to 12'	5 A, 125 VAC (GMA)	214-105
	Hose 12'-20'	8 A, 125 VAC (GMA)	214-108
	Hose 20'-24'	10 A, 125 VAC (GMA)	214-110
F4/F4B	Handgun	2 A, 125 VAC (GMA)	214-102
	Automatic Valve	-	Call TSS
F5/F5B	Hose up to 12'	5 A, 125 VAC (GMA)	214-105
	Hose 12'-20'	8 A, 125 VAC (GMA)	214-108
	Hose 20'-24'	10 A, 125 VAC (GMA)	214-110
F6/F6B	Handgun	2 A, 125 VAC (GMA)	214-102
	Automatic Valve	-	Call TSS
F7/F8	DC Power Supply	2 A, 250 VAC (GMD)	214-503

MOTOR CONTROL BOARD			
ITEM	DESCRIPTION	REPLACE WITH	PART NO
F1/F2	Transformer Primary	1 A, 125 VAC (GMA)	214-101
F4	Transformer Secondary	1 A, 125 VAC (GMA)	214-101
F5/F7	A/C Motor	5 A, 125 VAC (GMA)	214-105
	D/C Motor	8 A, 125 VAC (GMA)	214-108
F8/F10	Accessory Output	2 A, 125 VAC (GMA)	214-102



Schematic Single Motor

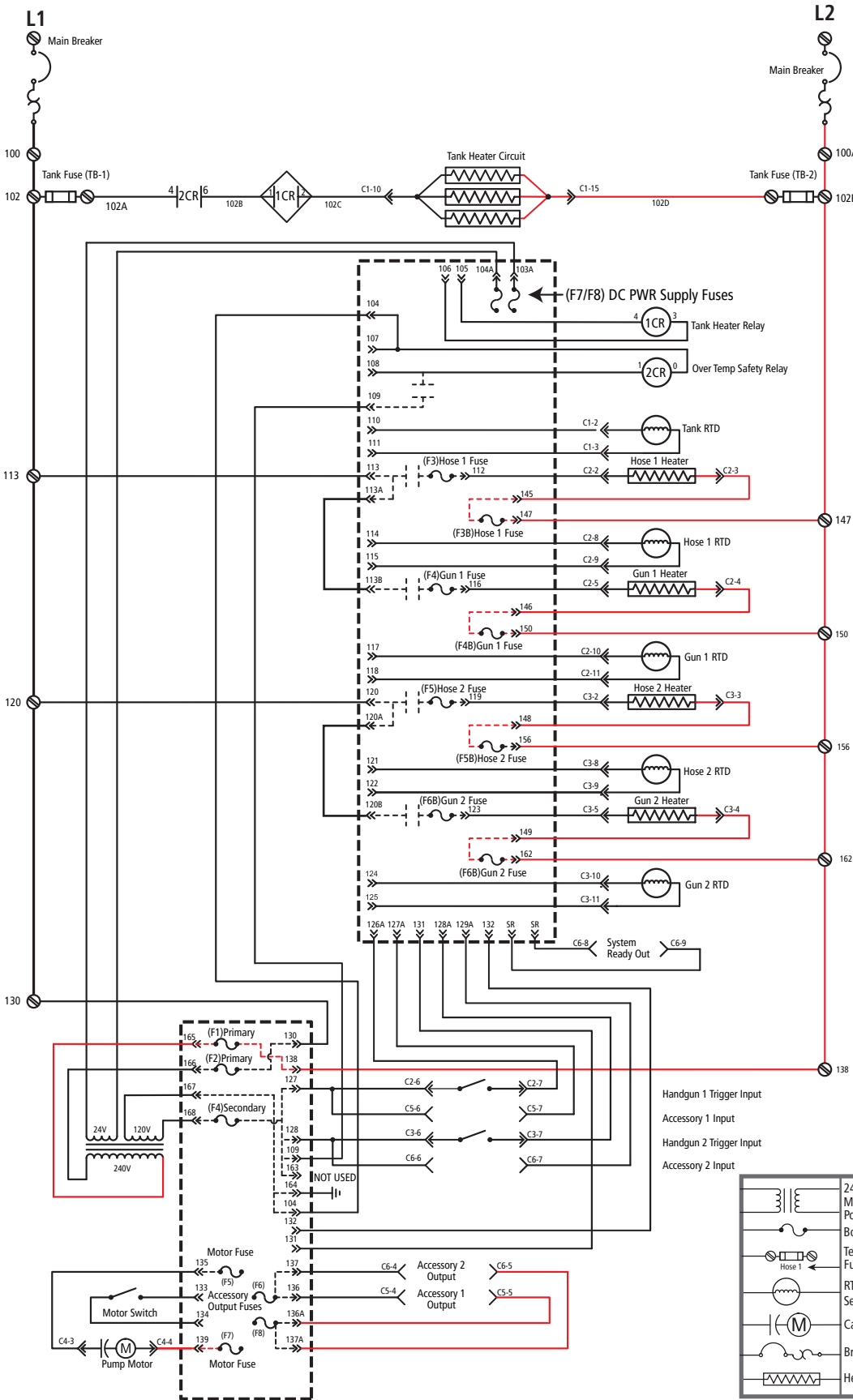

POWER CONNECTION

220 VAC, Single Phase

L1 ← 220V → L2 G

CONNECTOR IDENTIFICATION

C1	Tank
C2	Hose 1
C3	Hose 2
C4	Motor 1
C5	Accessory 1
C6	Accessory 2

SYMBOL LEGEND

	24V Transformer Motherboard Power Supply		Relay Number Relay (Coil) Wire Location
	Board Mounted Fuse		Relay Number Relay (Contacts) Wire Location
	Terminal Block Fuse Description		AMP Connector & Pin Number
	RTD Temperature Sensor		Stakon Connector
	Capacitor and Motor		Wire Termination
	Breaker Switch		Amber Light
	Heater		



Warranty Information

This Warranty extends to the original purchaser only and commences on the date of the original purchase.

Any part of the Hot Melt Technologies (HMT®) adhesive supply unit (ASU) manufactured by HMT® and found in the reasonable judgement of HMT to be defective in material and workmanship, will be repaired or replaced by HMT without charge for parts or labor.

This Warranty is limited to:

- a) One (1) year from initial use,
- b) Eighteen (18) months from date of purchase, or
- c) Two thousand (2,000) hours of use, whichever comes first.

The ASU including any defective part must be returned to HMT within the warranty period. All transportation expenses to HMT for warranty work and the expense of returning it to the owner will be paid for by the owner. HMT's responsibility in respect to claims is limited to (at its option) making the required repairs, adjustment, or replacements. No claim of breach of warranty shall be cause for cancellation of the contract of sale of any HMT ASU.

This warranty does not cover any ASU that has been subject to misuse, abuse, negligence, or accident, or which has been operated in any way contrary to the operating instructions. Warranty does not apply to any damage to the ASU that is the result of improper maintenance or installation.

This warranty does not cover any ASU that has been altered or modified by the customer. In addition, the warranty does not extend to repairs made necessary by normal wear or by the use of hot melt materials in the ASU which in the reasonable opinion of HMT are either incompatible with the ASU or adversely affect its operation, performance, or durability. This warranty does not extend to any accessory attachments to the ASU that are warranted separately for different periods of time. Other components supplied by HMT as part of a system will carry the warranty of the original manufacturer.

This warranty does not extend to an ASU damaged during shipment. Risk of loss or damage to the ASU shall pass to the buyer.

HMT reserves the right to change or improve the design of any ASU, or part of an ASU, without assuming any obligation to modify any ASU previously manufactured.

HMT assumes no responsibility for incidental, consequential or other damages including but not limited to: expense for hot melts, delivery or return freight expenses, mechanics travel time, telephone or telegraph charges, rental of a like product during the time warranty repairs are being performed, travel, loss or damage to personal property, loss of revenue, loss of use of the ASU, loss of time or inconvenience.